



Finitura: Laccato Rubino Lucido - Piano integrato in Tecnoril®  
Finishing: Laquered Glossy Rubino - Tecnoril® fitted in top

K&K



K&K



Finitura: Laccato luta Lucido - Top: Vetro extrachiaro luta  
Finishing: Laquered Glossy luta - Top: Extraclear glass luta





Finitura: Laccato Perla Opaco - Top: Aida White  
Finishing: Laquered Matt Perla - Top: Aida White





Finitura: Laccato Bianco Opaco - Top vetro extrachiaro Nero  
Finishing: Laquered Matt White - Top: Extraclear glass Black



K&K KC4







Finitura: Laccato Bianco Lucido - Top: Bianco Aosta  
Finishing: Laquered Glossy White - Top: Bianco Aosta



## FINITURE ANTA / DOOR FINISHING

Anta piena <i>Full door finishing</i>	Ante di complemento <i>Complementary doors</i>	
		
<p>ANTA PIENA colori laccati opachi e lucidi (18 colori) <i>FULL DOOR</i> matt and glossy colors (18 colors)</p>	<p>ANTA TELAIO + VETRO colori laccati opachi e lucidi (18 colori) + vetro opaco <i>FRAMED DOOR + GLASS</i> matt and glossy colors (18 colors) + matt glass</p>	<p>ANTA PROFILO ALLUMINIO + VETRO profilo alluminio + vetro opaco <i>ALUMINIUM PROFILE DOOR + GLASS</i> aluminium profile + matt glass</p>

## COLORI LACCATI OPACHI E LUCIDI / GLOSSY AND MATT COLORS

<p>BIANCO</p> 	<p>NERO</p> 	<p>ARAGOSTA</p> 	<p>RUBINO</p> 
<p>opaco / matt 13 lucido / glossy 15</p>	<p>opaco / matt 19 lucido / glossy PC</p>	<p>opaco / matt F1 lucido / glossy G1</p>	<p>opaco / matt F2 lucido / glossy G2</p>
<p>GIACINTO</p> 	<p>LAVANDA</p> 	<p>SENAPE</p> 	<p>LIME</p> 
<p>opaco / matt F3 lucido / glossy G3</p>	<p>opaco / matt F4 lucido / glossy G4</p>	<p>opaco / matt F5 lucido / glossy G5</p>	<p>opaco / matt F6 lucido / glossy G6</p>
<p>TURCHINO</p> 	<p>ARTICO</p> 	<p>FUCILE</p> 	<p>CORTECCIA</p> 
<p>opaco / matt F7 lucido / glossy G7</p>	<p>opaco / matt F8 lucido / glossy G8</p>	<p>opaco / matt F9 lucido / glossy G9</p>	<p>opaco / matt FA lucido / glossy GA</p>
<p>TERRA</p> 	<p>IUTA</p> 	<p>PERLA</p> 	<p>PLATINO</p> 
<p>opaco / matt FB lucido / glossy GB</p>	<p>opaco / matt FC lucido / glossy GC</p>	<p>opaco / matt FD lucido / glossy GD</p>	<p>opaco / matt FE lucido / glossy GE</p>
<p>TITANIO</p> 	<p>UMBRA</p> 	<p>Maggiorazione RAL: colori laccati opachi e lucidi gamma RAL a richiesta aumento 15%. RAL MARK-UP: RAL matt and shiny lacquered colors, available on request with 15% additional charge.</p>	
<p>opaco / matt FF lucido / glossy GF</p>	<p>opaco / matt 5V lucido / glossy 6V</p>		

## MANIGLIE / HANDLES

K



F3



N



K Larghezza 12 cm, finitura ALLUMINIO  
K Width 12 cm, ALUMINIUM finish

F3 Larghezza 14 cm, finitura CROMO  
F3 Width 14 cm, CHROME finish

N finitura CROMO e ORO  
N CHROME finish and GOLD

## FINITURA ZOCCOLO / SKIRTING FINISHING



Alluminio naturale / Alluminio laccato opaco e lucido (18 colori) H. 10 cm  
Aluminium / Matt and glossy lacquered Aluminium (18 colors) H. 10 cm

## DISEGNO TECNICO / TECHNICAL SCHEME

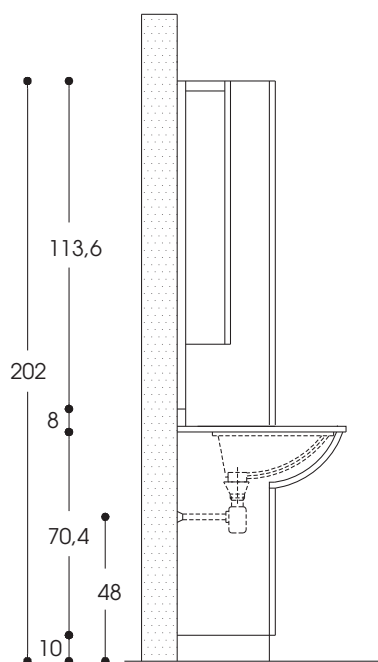

# MODULARITÀ / MODULARITY

## BASI PORTALAVABO SEMINCASSO P. 34 / SEMI-RECESSED WASHBASIN UNITS P. 34

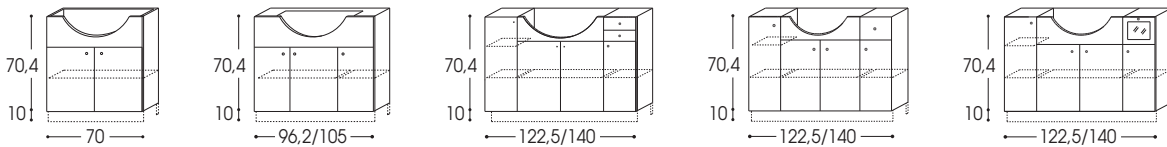

## BASI PORTALAVABO INCASSO TOTALE P. 34/57 / RECESSED WASHBASIN UNITS P. 34/57

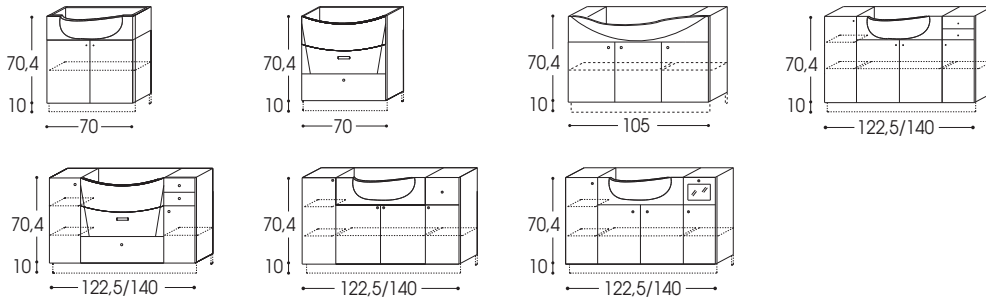

## BASE PORTALAVABO INCASSO TOTALE P. 34/48,5 / RECESSED WASHBASIN UNITS P. 34/48,5

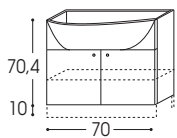

## BASE PORTALAVABO INCASSO TOTALE P. 34/60 / RECESSED WASHBASIN UNITS P. 34/60

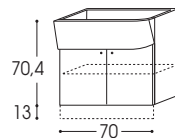

da affiancare alla base p.lavatrice P. 60  
to put beside the washing-machine unit D. 60

## BASI P. 34 / BASES P. 34

## BASI TERMINALI / TERMINAL UNITS

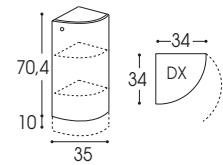
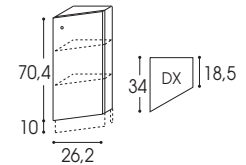
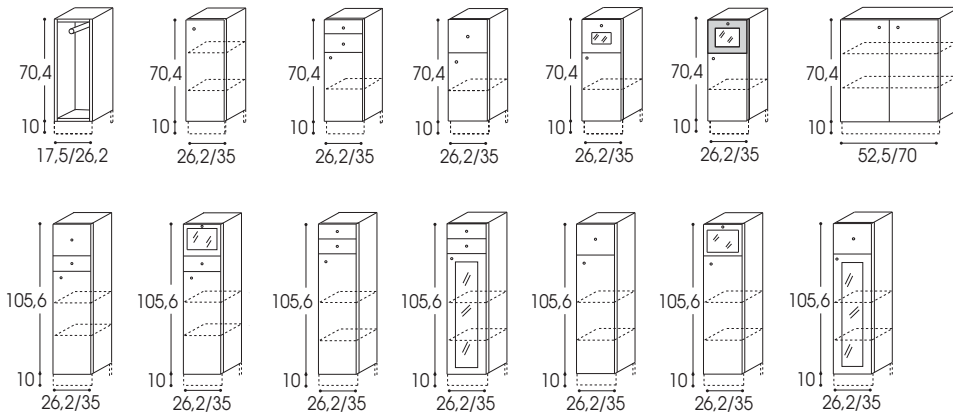

## BASI PORTALAVATRICE / WASHING MACHINE UNITS

## COLONNA PORTALAVATRICE / WASHING MACHINE COLUMN

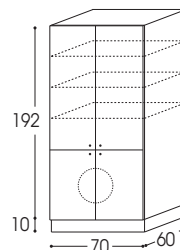
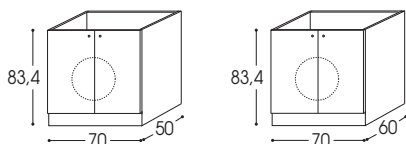

COLONNE P. 34 / COLUMNS P. 34

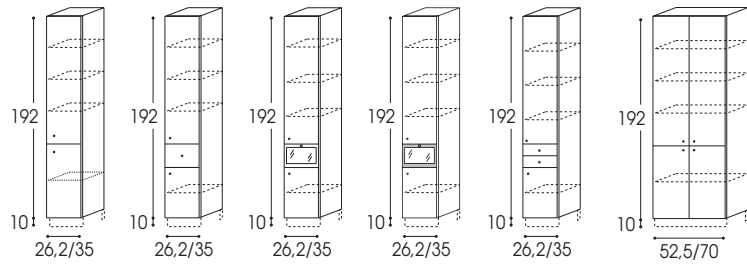

PENSILI CON VANETTO P. 18,5 / WALL UNITS WITH COMPARTMENTS P. 18,5

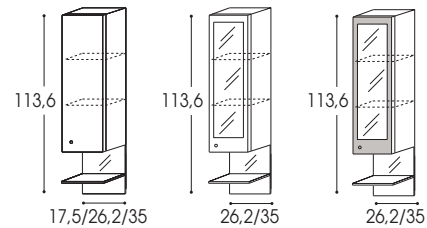

PENSILI P. 18,5 / WALL UNITS D. 18,5

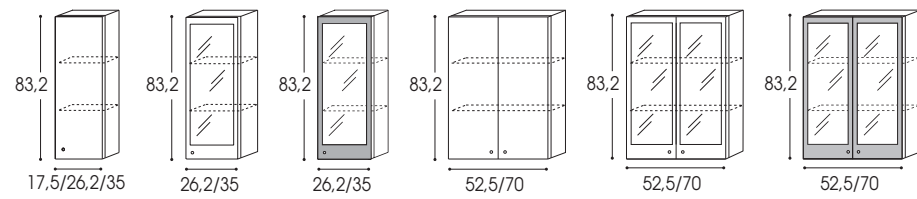

VANETTI A SPECCHIO / MIRROR COMPARTMENTS

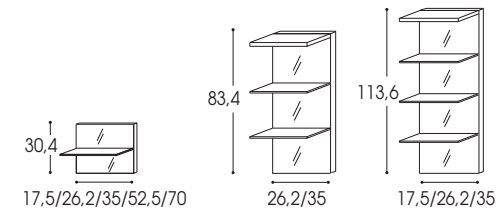

SPECCHI CON PENSILE P.18,5  
MIRRORS WITH HANGING UNIT D.18,5

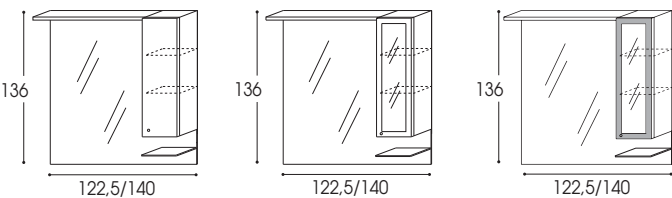

SPECCHI CON MENSOLE P.18,5  
MIRRORS WITH SHELVES D.18,5

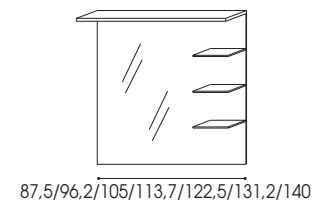

SPECCHI P.18,5 / MIRROR D.18,5

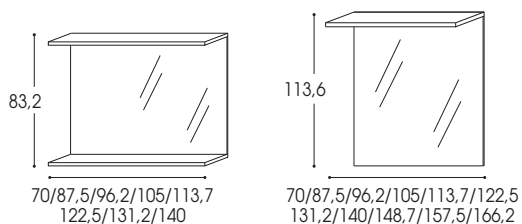

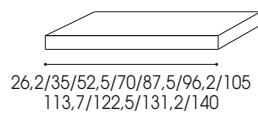

MENSOLE P.18,5 / SHELVES D.18,5



BASI PORTALAVABO SEMINCASSO a terra o sospese, **PROFONDITÀ 34 CM**  
*Floor or suspended SEMI-RECESSED WASHBASIN UNITS, DEPTH 34 CM*

	Larghezza (cm)	Articolo	Prezzo
	Width (cm)	Code	Price

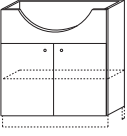
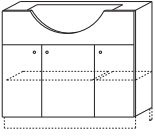
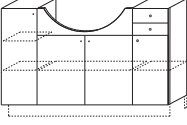
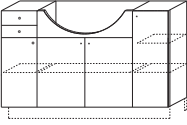
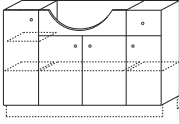
**Altezza fianchi / Sides height 70,4 cm**

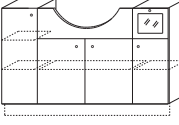
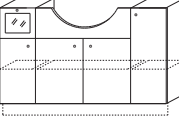
 due ante two doors	70	LAKM12D3	€ 606
 tre ante three doors	96,2	LAKM13I3	€ 711
	105	LAKM13E3	€ 885
 quattro ante / due cassetti a dx four doors / two right drawers	122,5	DAKM16F3	€ 997
	140	DAKM16G3	€ 1.068
 quattro ante / due cassetti a sx four doors / two left drawers	122,5	SAKM16F3	€ 997
	140	SAKM16G3	€ 1.068
 quattro ante / un cassetto a dx four doors / one right drawer	122,5	DAKM11F3	€ 1.050
	140	DAKM11G3	€ 1.125
 quattro ante / un cassetto a sx four doors / one left drawer	122,5	SAKM11F3	€ 1.050
	140	SAKM11G3	€ 1.125
 quattro ante / un cassetto laccato+vetro a dx four doors / one right lacq. drawer+glass	122,5	DAKM1LF3	€ 1.059
	140	DAKM1LG3	€ 1.135
 quattro ante / un cassetto laccato+vetro a sx four doors / one left lacq. drawer+glass	122,5	SAKM1LF3	€ 1.059
	140	SAKM1LG3	€ 1.135





BASI PORTALAVABO A TERRA CON ZOCCOLO H. 10 O SOSPESSE CON BARRA DI SOSTEGNO. Specificare al momento dell'ordine.  
 Il prezzo dello zoccolo o della barra di sostegno è compreso nel prezzo del mobile.  
 FLOOR WASHBASIN UNITS WITH BASE H. 10 OR SUSPENDED WITH SUPPORT BAR. Specify when ordering.  
 The price of the base or the support bar is included in the unit price.

BASI PORTALAVABO INCASSO TOTALE a terra o sospese, **PROFONDITÀ 34/57 CM**  
 Floor or suspended **RECESSED WASHBASIN UNITS, DEPTH 34/57 CM**

	Larghezza (cm)	Articolo	Prezzo
	Width (cm)	Code	Price

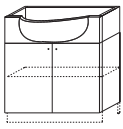
**Altezza fianchi / Sides height 70,4 cm**

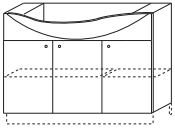
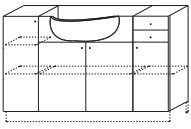
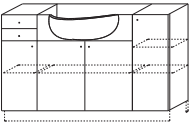
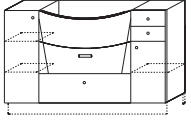
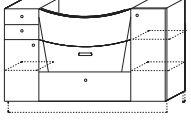
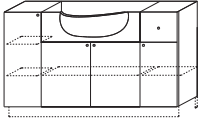
 due ante two doors	70	LAKM92D3	€ 692
 due cassetti two drawers	70	LAKMPD3 + LA1E24D5	€ 763
 tre ante three doors	105	LAKM33F6	€ 1.005
 quattro ante / due cassetti a dx four doors / two right drawers	122,5	DAKM96F3	€ 1.166
	140	DAKM96G3	€ 1.240
 quattro ante / due cassetti a sx four doors / two left drawers	122,5	SAKM96F3	€ 1.166
	140	SAKM96G3	€ 1.240
 due cassetti / due ante / due cassetti a dx two drawers / two doors / two right drawers	122,5	DAKMM6F3 + LA1E24D5	€ 1.177
	140	DAKMM6G3 + LA1E24D5	€ 1.296
 due cassetti / due ante / due cassetti a sx two drawers / two doors / two left drawers	122,5	SAKMM6F3 + LA1E24D5	€ 1.177
	140	SAKMM6G3 + LA1E24D5	€ 1.296
 quattro ante / un cassetto a dx four doors / one right drawer	122,5	DAKM9IF3	€ 1.189
	140	DAKM9IG3	€ 1.278



BASI PORTALAVABO A TERRA CON ZOCCOLO H. 10 O SOSPESE CON BARRA DI SOSTEGNO. Specificare al momento dell'ordine.  
 Il prezzo dello zoccolo o della barra di sostegno è compreso nel prezzo del mobile.  
 FLOOR WASHBASIN UNITS WITH BASE H. 10 OR SUSPENDED WITH SUPPORT BAR. Specify when ordering.  
 The price of the base or the support bar is included in the unit price.



BASI PORTALAVABO INCASSO TOTALE a terra o sospese, **PROFONDITÀ 34/57 CM**  
 Floor or suspended **RECESSED WASHBASIN UNITS, DEPTH 34/57 CM**

	Larghezza (cm)	Articolo	Prezzo
	Width (cm)	Code	Price

**Altezza fianchi / Sides height 70,4 cm**

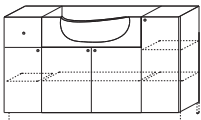
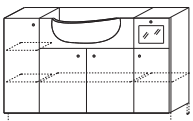
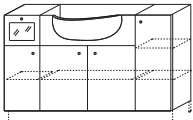
 quattro ante / un cassetto a sx four doors / one left drawer	122,5	SAKM9IF3	€ 1.189
	140	SAKM9IG3	€ 1.278
 quattro ante / un cassetto laccato+vetro a dx four doors / one right lacq. drawer+glass	122,5	DAKM9LF3	€ 1.198
	140	DAKM9LG3	€ 1.288
 quattro ante / un cassetto laccato+vetro a sx four doors / one left lacq. drawer+glass	122,5	SAKM9LF3	€ 1.198
	140	SAKM9LG3	€ 1.288

BASI PORTALAVABO INCASSO TOTALE a terra o sospese, **PROFONDITÀ RIDOTTA 34/48,5 CM**  
 Floor or suspended **RECESSED WASHBASIN UNITS, REDUCED DEPTH 34/48,5 CM**

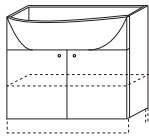
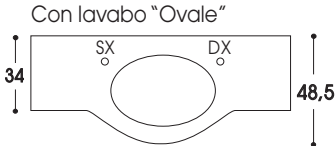

 due ante two doors	70	LAKMN2D3	€ 692
	<b>ATTENZIONE / ATTENTION:</b> Utilizzando il lavabo "Ovale" il foro rubinetto è posizionato a dx o a sx rispetto al foro lavabo. When using the "Ovale" washbasin the hole for the tap is on the left or right side of the washbasin tap.		

 BASI PORTALAVABO A TERRA CON ZOCCOLO H. 10 O SOSPESI CON BARRA DI SOSTEGNO. Specificare al momento dell'ordine. Il prezzo dello zoccolo o della barra di sostegno è compreso nel prezzo del mobile.  
 FLOOR WASHBASIN UNITS WITH BASE H. 10 OR SUSPENDED WITH SUPPORT BAR. Specify when ordering.  
 The price of the base or the support bar is included in the unit price.

BASI a terra o sospese, **PROFONDITÀ 34 CM**  
 Floor or suspended BASES, **DEPTH 34 CM**

	Apertura	Larghezza (cm)	Articolo	Prezzo
	Opening	Width (cm)	Code	Price

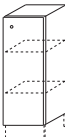
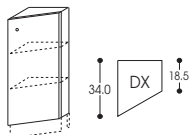
**Altezza fianchi / Sides height 70,4 cm**

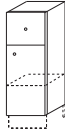
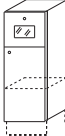
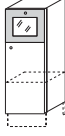
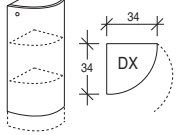
 portasalviette towel rail	-	17,5	LA0B2EA3	€ 285
	-	26,2	LA0B2EB3	€ 328
 un'anta one door	cerniere destra right hinges	26,2	DAKB21B3	€ 347
	cerniere sinistra left hinges		SAKB21B3	
	cerniere destra right hinges	35	DAKB21C3	€ 372
	cerniere sinistra left hinges		SAKB21C3	
 terminale un'anta one door terminal unit	cerniere destra right hinges	26,2	DAKQ11B3	€ 446
	cerniere sinistra left hinges		SAKQ11B3	
 un'anta / due cassetti one door / two drawers	cerniere destra right hinges	26,2	DAKB25B3	€ 437
	cerniere sinistra left hinges		SAKB25B3	
	cerniere destra right hinges	35	DAKB25C3	€ 469
	cerniere sinistra left hinges		SAKB25C3	
 un'anta / un cassetto one door / one drawer	cerniere destra right hinges	26,2	DAKB24B3	€ 437
	cerniere sinistra left hinges		SAKB24B3	
	cerniere destra right hinges	35	DAKB24C3	€ 469
	cerniere sinistra left hinges		SAKB24C3	
 un'anta / un cassetto laccato+vetro one door / one lacq. drawer+glass	cerniere destra right hinges	26,2	DAKB2GB3	€ 450
	cerniere sinistra left hinges		SAKB2GB3	
	cerniere destra right hinges	35	DAKB2GC3	€ 481
	cerniere sinistra left hinges		SAKB2GC3	
 un'anta / un cassetto prof. alluminio +vetro one door / one alu. prof. drawer+glass	cerniere destra right hinges	26,2	DAKB2QB3	€ 444
	cerniere sinistra left hinges		SAKB2QB3	
	cerniere destra right hinges	35	DAKB2QC3	€ 463
	cerniere sinistra left hinges		SAKB2QC3	
 terminale curvo un'anta one door curved terminal unit	cerniere destra right hinges	35	DAKI21C6	€ 644
	cerniere sinistra left hinges		SAKI21C6	



BASI A TERRA CON ZOCCOLO H. 10 O SOSPENSE CON BARRA DI SOSTEGNO. Specificare al momento dell'ordine.  
 Il prezzo dello zoccolo o della barra di sostegno è compreso nel prezzo del mobile.  
 FLOOR WASHBASIN UNITS WITH BASE H. 10 OR SUSPENDED WITH SUPPORT BAR. Specify when ordering.  
 The price of the base or the support bar is included in the unit price.



BASI a terra o sospese, **PROFONDITÀ 34 CM**  
*Floor or suspended BASES, DEPTH 34 CM*

	Apertura	Larghezza (cm)	Articolo	Prezzo
	<i>Opening</i>	<i>Width (cm)</i>	<i>Code</i>	<i>Price</i>

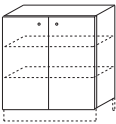
**Altezza fianchi / Sides height 70,4 cm**

 due ante <i>two doors</i>	-	52,5	LAKB22N3	€ 507
	-	70	LAKB22D3	€ 532

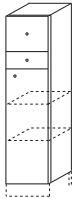
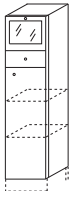
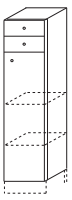
**Altezza fianchi / Sides height 105,6 cm**

 due cassetti / un'anta h. 70,4 <i>two drawers / one door h. 70,4</i>	cerniere destra <i>right hinges</i>	26,2	DAKB2IBA	€ 489
	cerniere sinistra <i>left hinges</i>		SAKB2IBA	
	cerniere destra <i>right hinges</i>	35	DAKB2ICA	€ 492
	cerniere sinistra <i>left hinges</i>		SAKB2ICA	
 un cassetto laccato+vetro un cassetto / un'anta h. 70,4 <i>one lacq. drawer+glass                      one drawer / one door h. 70,4</i>	cerniere destra <i>right hinges</i>	26,2	DAKB2HBA	€ 502
	cerniere sinistra <i>left hinges</i>		SAKB2HBA	
	cerniere destra <i>right hinges</i>	35	DAKB2HCA	€ 518
	cerniere sinistra <i>left hinges</i>		SAKB2HCA	
 due cassetti / un'anta h. 83,2 <i>two drawers / one door h. 83,2</i>	cerniere destra <i>right hinges</i>	26,2	DAKB25BA	€ 486
	cerniere sinistra <i>left hinges</i>		SAKB25BA	
	cerniere destra <i>right hinges</i>	35	DAKB25CA	€ 493
	cerniere sinistra <i>left hinges</i>		SAKB25CA	
 due cassetti / un'anta laccata+vetro h. 83,2 <i>two drawers / one lacq. door+glass h. 83,2</i>	cerniere destra <i>right hinges</i>	26,2	DALB25BA	€ 562
	cerniere sinistra <i>left hinges</i>		SALB25BA	
	cerniere destra <i>right hinges</i>	35	DALB25CA	€ 571
	cerniere sinistra <i>left hinges</i>		SALB25CA	



BASI A TERRA CON ZOCCOLO H. 10 O SOSPESE CON BARRA DI SOSTEGNO. Specificare al momento dell'ordine.  
 Il prezzo dello zoccolo o della barra di sostegno è compreso nel prezzo del mobile.  
 FLOOR WASHBASIN UNITS WITH BASE H. 10 OR SUSPENDED WITH SUPPORT BAR. Specify when ordering.  
 The price of the base or the support bar is included in the unit price.

BASI a terra o sospese, **PROFONDITÀ 34 CM**  
 Floor or suspended BASES, **DEPTH 34 CM**

	Apertura	Larghezza (cm)	Articolo	Prezzo
	Opening	Width (cm)	Code	Price

**Altezza fianchi / Sides height 105,6 cm**

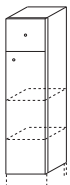
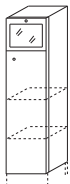
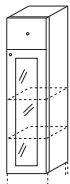
 un cassetto / un'anta h. 83,2 one drawer / one door h. 83,2	cerniere destra right hinges	26,2	DAKB24BA	€ 476
	cerniere sinistra left hinges		SAKB24BA	
	cerniere destra right hinges	35	DAKB24CA	€ 512
	cerniere sinistra left hinges		SAKB24CA	
 un cassetto laccato+vetro / un'anta h. 83,2 one lacq. drawer+glass / one door h. 83,2	cerniere destra right hinges	26,2	DAKB2GBA	€ 488
	cerniere sinistra left hinges		SAKB2GBA	
	cerniere destra right hinges	35	DAKB2GCA	€ 524
	cerniere sinistra left hinges		SAKB2GCA	
 un cassetto / un'anta laccata+vetro h. 83,2 one lacq. door+glass h. 83,2	cerniere destra right hinges	26,2	DALB24BA	€ 564
	cerniere sinistra left hinges		SALB24BA	
	cerniere destra right hinges	35	DALB24CA	€ 600
	cerniere sinistra left hinges		SALB24CA	



BASI A TERRA CON ZOCCOLO H. 10 O SOSPESSE CON BARRA DI SOSTEGNO. Specificare al momento dell'ordine.  
 Il prezzo dello zoccolo o della barra di sostegno è compreso nel prezzo del mobile.  
 FLOOR WASHBASIN UNITS WITH BASE H. 10 OR SUSPENDED WITH SUPPORT BAR. Specify when ordering.  
 The price of the base or the support bar is included in the unit price.

**BASI PORTALAVATRICE, LARGHEZZA 70 CM - PROFONDITÀ 50/60 CM**  
**WASHING-MACHINE UNIT BASES, WIDTH 70 CM - DEPTH 50/60 CM**

ESEMPIO DI MONTAGGIO IN COMPOSIZIONE CON PORTALAVATRICE H. 83,4 - ZOCCOLO H. 13.  
 EXAMPLE OF ASSEMBLY IN COLLECTION WITH WASHING-MACHINE UNIT H. 83.4 – SKIRTING H. 13.



Misure interne utili per lavatrice	Profondità (cm)	Articolo	Prezzo
<i>Useful internal measurements for washing-machine</i>	<i>Depth (cm)</i>	<i>Code</i>	<i>Price</i>

**Altezza fianchi / Sides height 83,4 cm**

 base portalavatrice / due ante washing-machine base / two doors	L. 61 P. 46 H. 83 W. 61 D. 46 H. 83	50	LAKB7AD8	€ 563
	L. 61 P. 56 H. 83 W. 61 D. 56 H. 83	60	LAKB3AD8	€ 594

**Altezza fianchi / Sides height 192 cm**

**zoccolo / skirting H. 10**

 colonna portalavatrice / quattro ante washing-machine column / four doors	L. 61 P. 56 H. 84 W. 61 D. 56 H. 84	60	LAKC3BDA	€ 1.300
--	--	----	----------	---------

**Altezza fianchi / Sides height 70,4 cm**

**zoccolo / skirting H. 13**

portalavabo P. 60/34 da affiancare alla base portalavatrice P. 60 / due ante Washbasin holder D. 60/34 to put beside the washing-machine unit / two doors	Versione	Profondità (cm)	Articolo	Prezzo
	<i>Version</i>	<i>Depth (cm)</i>	<i>Code</i>	<i>Price</i>
 versione destra right version	60/34	DAKM72D3	€ 696	
				 versione sinistra left version



BASE PORTALAVABO A TERRA CON ZOCCOLO O SOSPESA CON BARRA DI SOSTEGNO. Specificare al momento dell'ordine.  
 Il prezzo dello zoccolo o della barra di sostegno è compreso nel prezzo del mobile.  
 FLOOR WASHBASIN UNITS WITH BASE H. 10 OR SUSPENDED WITH SUPPORT BAR. Specify when ordering.  
 The price of the base or the support bar is included in the unit price.

COLONNE a terra o sospese, **PROFONDITÀ 34 CM**  
 Floor or suspended **COLUMNS, DEPTH 34 CM**

	Apertura	Larghezza (cm)	Articolo	Prezzo
	Opening	Width (cm)	Code	Price

**Altezza fianchi / Sides height 192 cm**

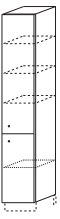
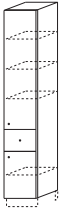
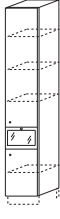
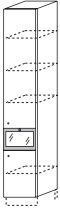
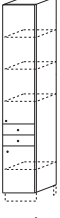
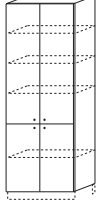
 due ante two doors	cerniere destra right hinges	26,2	DAKC23BA	€ 676
	cerniere sinistra left hinges		SAKC23BA	
	cerniere destra right hinges	35	DAKC23CA	€ 738
	cerniere sinistra left hinges		SAKC23CA	
 due ante / un cassetto two doors / one drawer	cerniere destra right hinges	26,2	DAKC24BA	€ 759
	cerniere sinistra left hinges		SAKC24BA	
	cerniere destra right hinges	35	DAKC24CA	€ 788
	cerniere sinistra left hinges		SAKC24CA	
 due ante / un cassetto laccato+vetro two doors / one lacq. drawer+glass	cerniere destra right hinges	26,2	DAKC2LBA	€ 772
	cerniere sinistra left hinges		SAKC2LBA	
	cerniere destra right hinges	35	DAKC2LCA	€ 800
	cerniere sinistra left hinges		SAKC2LCA	
 due ante / un cassetto prof. alluminio+vetro two doors / one alu. prof. drawer+glass	cerniere destra right hinges	26,2	DAKC2SBA	€ 768
	cerniere sinistra left hinges		SAKC2SBA	
	cerniere destra right hinges	35	DAKC2SCA	€ 812
	cerniere sinistra left hinges		SAKC2SCA	
 due ante / due cassetti two doors / two drawers	cerniere destra right hinges	26,2	DAKC25BA	€ 772
	cerniere sinistra left hinges		SAKC25BA	
	cerniere destra right hinges	35	DAKC25CA	€ 842
	cerniere sinistra left hinges		SAKC25CA	
 quattro ante four doors	-	52,5	LAKC2HNA	€ 1.060
	-	70	LAKC2HDA	€ 1.150



COLONNE A TERRA CON ZOCCOLO H. 10 O SOSPESSE CON BARRA DI SOSTEGNO. Specificare al momento dell'ordine.  
 Il prezzo dello zoccolo o della barra di sostegno è compreso nel prezzo del mobile.  
 FLOOR COLUMN WITH BASE H. 10 OR SUSPENDED WITH SUPPORT BAR. Specify when ordering.  
 The price of the base or the support bar is included in the unit price.

PENSILI CON VANETTO, **ALTEZZA 113,6 CM - PROFONDITÀ 18,5 CM** da affiancare a specchi h. 113,6 cm  
 WALL UNITS, **HEIGHT 113,6 CM - DEPTH 18,5 CM** to combine with mirrors h. 113.6 cm

ESEMPIO DI COMPOSIZIONE / EXAMPLE OF COMPOSITION

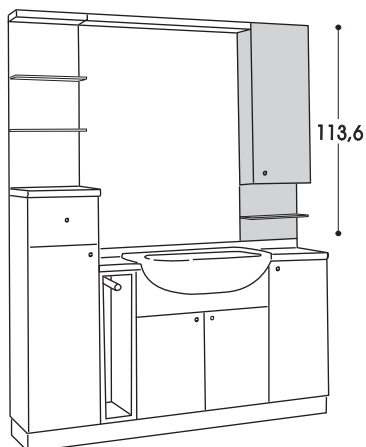



PENSILI  
OPEN CUPBOARDS

	Apertura	Larghezza (cm)	Articolo	Prezzo
	Opening	Width (cm)	Code	Price

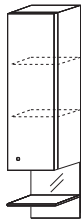
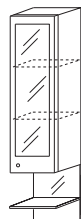
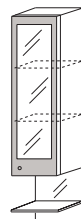
Altezza / Height 113,6 cm

 <p>un'anta h. 83,2 / una mensola a vetro schiena a specchio one door h. 83,2 / one glass shelf back of the cabinet made in mirror</p>	cerniere destra right hinges	17,5	DAKPA5A8	€ 287
	cerniere sinistra left hinges		SAKPA5A8	
	cerniere destra right hinges	26,2	DAKPA5B8	€ 331
	cerniere sinistra left hinges		SAKPA5B8	
	cerniere destra right hinges	35	DAKPA5C8	€ 391
	cerniere sinistra left hinges		SAKPA5C8	
 <p>un'anta h. 83,2 laccata+vetro una mensola a vetro / schiena a specchio one lacq. door+glass h. 83,2 / one glass shelf back of the cabinet made in mirror</p>	cerniere destra right hinges	26,2	DALPA5B8	€ 434
	cerniere sinistra left hinges		SALPA5B8	
	cerniere destra right hinges	35	DALPA5C8	€ 480
	cerniere sinistra left hinges		SALPA5C8	
 <p>un'anta h. 83,2 prof. alluminio+vetro una mensola a vetro / schiena a specchio one alu. prof. door+glass h. 83,2 / one glass shelf back of the cabinet made in mirror</p>	cerniere destra right hinges	26,2	DANPA5B8	€ 414
	cerniere sinistra left hinges		SANPA5B8	
	cerniere destra right hinges	35	DANPA5C8	€ 463
	cerniere sinistra left hinges		SANPA5C8	

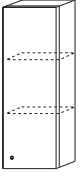
PENSILI, ALTEZZA 83,2 CM - PROFONDITÀ 18,5 CM da affiancare a specchi h. 83,2 cm  
 WALL UNITS, HEIGHT 83,2 CM - DEPTH 18,5 CM to combine with mirrors h. 83.2 cm

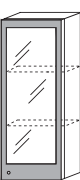
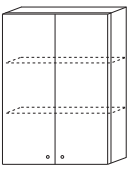
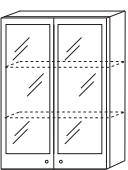
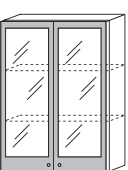
	Apertura	Larghezza (cm)	Articolo	Prezzo
	Opening	Width (cm)	Code	Price
<b>Altezza / Height 83,2 cm</b>				
 un'anta one door	cerniere destra right hinges	17,5	DAKPA1A6	€ 273
	cerniere sinistra left hinges		SAKPA1A6	
	cerniere destra right hinges	26,2	DAKPA1B6	€ 301
	cerniere sinistra left hinges		SAKPA1B6	
	cerniere destra right hinges	35	DAKPA1C6	€ 331
	cerniere sinistra left hinges		SAKPA1C6	
 un'anta laccata+vetro one lacq. door+glass	cerniere destra right hinges	26,2	DALPA1B6	€ 324
	cerniere sinistra left hinges		SALPA1B6	
	cerniere destra right hinges	35	DALPA1C6	€ 368
	cerniere sinistra left hinges		SALPA1C6	
 un'anta prof. alluminio+vetro one alu. prof. door+glass	cerniere destra right hinges	26,2	DANPA1B6	€ 355
	cerniere sinistra left hinges		SANPA1B6	
	cerniere destra right hinges	35	DANPA1C6	€ 381
	cerniere sinistra left hinges		SANPA1C6	
 due ante one alu. prof. door+glass	-	52,5	LAKPA2E6	€ 464
	-	70	LAKPA2D6	€ 489
 due ante laccate+vetro two lacq. doors+glass	-	52,5	LALPA2E6	€ 616
	-	70	LALPA2D6	€ 643
 due ante prof. alluminio+vetro two alu. prof. doors+glass	-	52,5	LANPA2E6	€ 635
	-	70	LANPA2D6	€ 705



VANETTI A SPECCHIO con mensole in vetro, **PROFONDITÀ 15,2 CM**  
 MIRROR COMPARTMENTS with glass shelves, **DEPTH 15,2 CM**

VANETTI  
COMPARTMENTS

ESEMPIO DI COMPOSIZIONE / EXAMPLE OF COMPOSITION

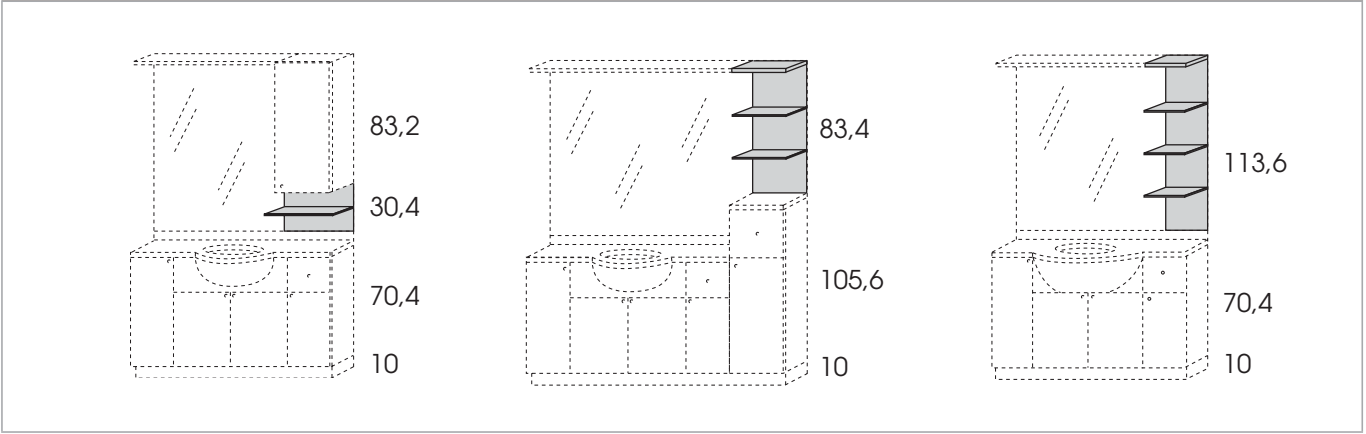

	Larghezza (cm)	Articolo	Prezzo
	Width (cm)	Code	Price

**Altezza / Height 30,4 cm**

 a specchio / una mensola vetro mirror / one glass shelf	17,5	LC1V11AB	€ 73
	26,2	LC1V11BB	€ 78
	35	LC1V11CB	€ 86
	52,5	LC1V11EB	€ 107
	70	LC1V11DB	€ 119

**Altezza / Height 83,4 cm**

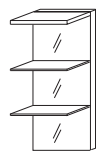
 a specchio / due mensole vetro mensola superiore laccata mirror / two glass shelves lacquered top shelf	26,2	LA5V21B4	€ 216
	35	LA5V21C4	€ 223

**Altezza / Height 113,6 cm**

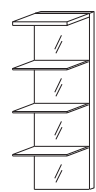
 a specchio / tre mensole vetro mensola superiore laccata mirror / three glass shelves lacquered top shelf	17,5	LA5V31AC	€ 206
	26,2	LA5V31BC	€ 234
	35	LA5V31CC	€ 270

SPECCHI DA APPOGGIO con pensile e mensola superiore con faretti, **ALTEZZA 113,6 CM - PROF. 15,2 CM**  
 TABLETOP MIRRORS with wall cabinet and top shelf with spotlights, **HEIGHT 113,6 CM - DEPTH 15,2 CM**

	Posizione pensile	Dimensione pensile	N. faretti	Larghezza (cm)	Articolo	Prezzo
	<i>Hanging unit position</i>	<i>Hanging unit dimension</i>	<i>N. lights</i>	<i>Width (cm)</i>	<i>Code</i>	<i>Price</i>

**Altezza / Height 113,6 cm**

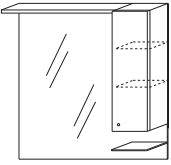
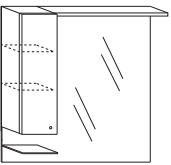
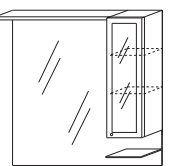
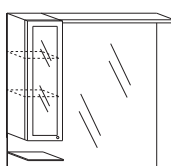
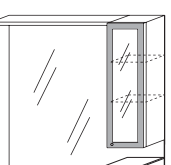
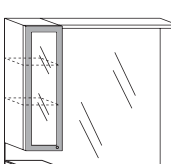
 un'anta / una mensola vetro <i>one door / one glass shelf</i>	pensile a dx <i>right wall unit</i>	26,2	3	122,5	DAKS7DIA	€ 723
		35	3	140	DAKS7DKA	€ 760
 un'anta / una mensola vetro <i>one door / one glass shelf</i>	pensile a sx <i>left wall unit</i>	26,2	3	122,5	SAKS7DIA	€ 723
		35	3	140	SAKS7DKA	€ 760
 un'anta laccata+vetro / una mensola vetro <i>one lacq. door+glass / one glass shelf</i>	pensile a dx <i>right wall unit</i>	26,2	3	122,5	DALS7DIA	€ 800
		35	3	140	DALS7DKA	€ 866
 un'anta laccata+vetro / una mensola vetro <i>one lacq. door+glass / one glass shelf</i>	pensile a sx <i>left wall unit</i>	26,2	3	122,5	SALS7DIA	€ 800
		35	3	140	SALS7DKA	€ 866
 un'anta prof. alluminio+vetro / una mensola vetro <i>one alu. prof. door+glass / one glass shelf</i>	pensile a dx <i>right wall unit</i>	26,2	3	122,5	DANS7DIA	€ 799
		35	3	140	DANS7DKA	€ 866
 un'anta prof. alluminio+vetro / una mensola vetro <i>one alu. prof. door+glass / one glass shelf</i>	pensile a sx <i>left wall unit</i>	26,2	3	122,5	SANS7DIA	€ 799
		35	3	140	SANS7DKA	€ 866

**FARETTO ALOGENO / HALOGEN SPOT LIGHT**

Descrizione / Description	INDICARE SEMPRE IL COLORE ALWAYS INDICATE THE COLOUR
 ALOGENO "C"      Colori: cromato, dorato Colours: chrome-plated, gold-plated	Maggiorazione per presa e interruttore internazionale: € 15 netti Supplement for socket + international switch please add € 15 net



Presca interruttore a dx su mensola con faretti  
 Socket and switch on light shelf on the right

SPECCHI DA APPOGGIO con mensole vetro e mensola superiore con faretto, **ALTEZZA 113,6 CM - PROF. 15,2 CM**  
 TABLETOP MIRRORS with glass shelves and top shelf with spotlights, **HEIGHT 113,6 CM - DEPTH 15,2 CM**

	Posizione mensole vetro	Dimensione mensole vetro	N. faretti	Larghezza (cm)	Articolo	Prezzo
	Glass shelves position	Glass shelves dimension	N. lights	Width (cm)	Code	Price

**Altezza / Height 113,6 cm**

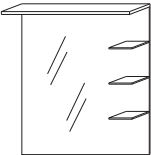
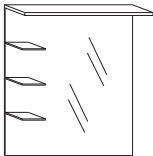
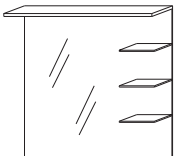
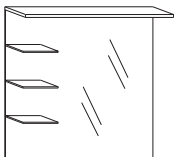
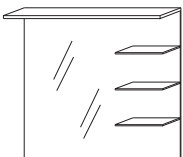
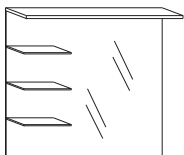
 tre mensole vetro three glass shelves	mensole a dx right shelves	17,5	2	87,5	DA1S74EA	€ 469
			3	96,2	DA1S74MA	€ 477
			3	105	DA1S74GA	€ 485
			3	113,7	DA1S74RA	€ 547
 tre mensole vetro three glass shelves	mensole a sx left shelves	17,5	2	87,5	SA1S74EA	€ 469
			3	96,2	SA1S74MA	€ 477
			3	105	SA1S74GA	€ 485
			3	113,7	SA1S74RA	€ 547
 tre mensole vetro three glass shelves	mensole a dx right shelves	26,2	3	96,2	DA1S74FA	€ 511
			3	122,5	DA1S74IA	€ 574
 tre mensole vetro three glass shelves	mensole a sx left shelves	26,2	3	96,2	SA1S74FA	€ 511
			3	122,5	SA1S74IA	€ 574
 tre mensole vetro three glass shelves	mensole a dx right shelves	35	3	105	DA1S74NA	€ 564
			4	131,2	DA1S74JA	€ 600
			4	140	DA1S74KA	€ 651
 tre mensole vetro three glass shelves	mensole a sx left shelves	35	3	105	SA1S74NA	€ 564
			4	131,2	SA1S74JA	€ 600
			4	140	SA1S74KA	€ 651

**FARETTO ALOGENO / HALOGEN SPOT LIGHT**

Descrizione / Description	INDICARE SEMPRE IL COLORE ALWAYS INDICATE THE COLOUR
 ALOGENO "C"      Colori: cromato, dorato Colours: chrome-plated, gold-plated	Maggiorazione per presa e interruttore internazionale: € 15 netti Supplement for socket + international switch please add € 15 net



Presca interruttore a dx su mensola con faretto  
 Socket and switch on light shelf on the right

SPECCHI DA APPOGGIO con mensola superiore laccata con faretti, **ALTEZZA 113,6 CM - PROF. 15,2 CM**  
 HANGING MIRRORS with lacquered top shelves with spotlights, **HEIGHT 113,6 CM - DEPTH 15,2 CM**

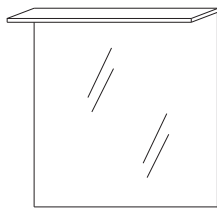

presa interruttore a dx su mensola con faretti  
 socket and switch on light shelf on the right

Larghezza Width	70	87,5	96,2	105	113,7	122,5	131,2	140	148,7	157,5	166,2
N. faretti N. lights	2	2	3	3	3	3	4	4	4	5	5
Articolo Code	LA1S79CA	LA1S79EA	LA1S79FA	LA1S79GA	LA1S79HA	LA1S79IA	LA1S79JA	LA1S79KA	LA1S79LA	LA1S79MA	LA1S79NA
Prezzo Price	€ 376	€ 419	€ 432	€ 444	€ 506	€ 513	€ 533	€ 584	€ 635	€ 720	€ 771

SPECCHI SOSPESI con mensole laccate - mensola superiore con faretti, **ALTEZZA 83,2 CM - PROF. 18,5 CM**  
 HANGING MIRRORS with lacquered shelves - top shelf with spotlights, **HEIGHT 83,2 CM - DEPTH 18,5 CM**

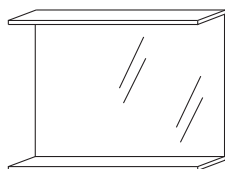

presa interruttore a dx su mensola con faretti  
 socket and switch on light shelf on the right

Larghezza Width	70	87,5	96,2	105	113,7	122,5	131,2	140
N. faretti N. lights	2	2	3	3	3	3	4	4
Articolo Code	LA1SCGCF	LA1SCGEF	LA1SCGFF	LA1SCGGF	LA1SCGHF	LA1SCGIF	LA1SCGJF	LA1SCGKF
Prezzo Price	€ 412	€ 451	€ 475	€ 499	€ 576	€ 599	€ 628	€ 688

FARETTO ALOGENO / HALOGEN SPOT LIGHT

Descrizione / Description		<b>INDICARE SEMPRE IL COLORE</b> <b>ALWAYS INDICATE THE COLOUR</b>
	ALOGENO "C"      Colori: cromato, dorato Colours: chrome-plated, gold-plated	Maggiorazione per presa e interruttore internazionale: € 15 netti Supplement for socket + international switch please add € 15 net



PER SPECCHI LISCI E SPECCHIERE VEDI SEZIONE SPECCHI da pag. 180  
 FOR SMOOTH MIRRORS AND MIRRORS SEE THE MIRROR'S SECTION from page. 180

MENSOLE LACCATE, PROFONDITÀ 13,2 CM - SPESSORE 3,5 CM  
 LACQUERED SHELVES, DEPTH 13,2 CM - THICKNESS 3,5 CM

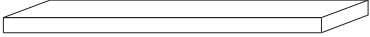
	Larghezza (cm)	Articolo	Prezzo
	Width (cm)	Code	Price
	26,2	L55Y1003	€ 66
	35	L55Y1004	€ 75
	52,5	L55Y1006	€ 93
	70	L55Y1008	€ 105
	87,5	L55T1010	€ 115
	96,2	L55T1011	€ 119
	105	L55T1012	€ 128
	113,7	L55T1013	€ 137
	122,5	L55T1014	€ 147
	131,2	L55T1015	€ 157
	140	L55T1016	€ 167



Le mensole sono complete di fissaggi a scomparsa  
 Shelves are equipped with concealed fixing

## TOP VETRO EXTRACHIARO E VETRO EXTRACHIARO SATINATO EXTRACLEAR AND EXTRACLEAR SATIN GLASS TOP

BIANCO



extrachiaro / extraclear C1  
satinato / satin IF

NERO



extrachiaro / extraclear C2  
satinato / satin IG

ARAGOSTA



extrachiaro / extraclear C3  
satinato / satin IH

RUBINO



extrachiaro / extraclear C4  
satinato / satin LP

GIACINTO



extrachiaro / extraclear C5  
satinato / satin IK

LAVANDA



extrachiaro / extraclear C6  
satinato / satin IL

SENAPE



extrachiaro / extraclear C7  
satinato / satin IM

LIME



extrachiaro / extraclear C8  
satinato / satin IN

TURCHINO



extrachiaro / extraclear C9  
satinato / satin IP

ARTICO



extrachiaro / extraclear CA  
satinato / satin IQ

FUCILE



extrachiaro / extraclear CB  
satinato / satin IR

CORTECCIA



extrachiaro / extraclear CC  
satinato / satin IS

TERRA



extrachiaro / extraclear CD  
satinato / satin IT

IUTA



extrachiaro / extraclear CE  
satinato / satin IU

PERLA



extrachiaro / extraclear CF  
satinato / satin IW

PLATINO



extrachiaro / extraclear CG  
satinato / satin IX

TITANIO



extrachiaro / extraclear CL  
satinato / satin LM

UMBRA

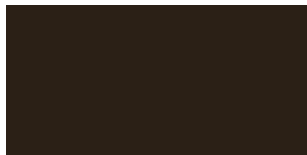

extrachiaro / extraclear CM  
satinato / satin LN

Il top vetro extrachiaro satinato viene fornito con trattamento antimacchia.

RAL MARK-UP: RAL matt and shiny lacquered colors, available on request with 15% additional charge.

## TOP TECNORIL TECNORIL TOP

BIANCO OPACO  
MATT WHITE



D2

TOP MARMO  
MARBLE TOP

gruppo  
group

A

MARMO CARRARA



71

TOP MARMORESINA  
MARBLERESIN TOP

BOTTICINO



HJ

BIANCO AOSTA



HK

PERLINO ROSATO



HR

ROSSO ASIAGO



PK

PERLATO APPIA



KA

TOP MARMO  
MARBLE TOP

gruppo  
group

B

VERDE GUATEMALA

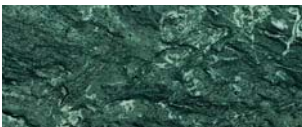

64

CALACATTA



32

TOP MARMORESINA  
MARBLERESIN TOP

POLARE

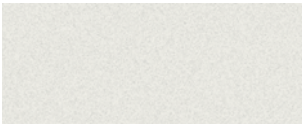

LX

SOLE

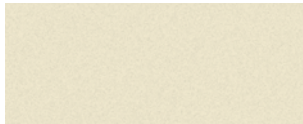

LY

AIDA WHITE



M6

TOP QUARZO  
QUARTZ TOP

gruppo  
group

D

ICE



HD

GREY



HL

BLUE



HE

NERO



K4

BEIGE ARENA SPAZZOLATO

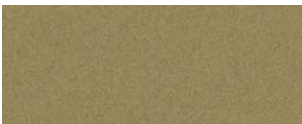

M3

SPACCATO VULCANO



K7

SPACCATO PHUKET



K6

SPACCATO GUAM



K5

# REGOLE PER I PIANI TOP

## RULES FOR TOP

### COSA COMUNICARE AL MOMENTO DELL'ORDINE

#### WHAT TO COMMUNICATE WHEN ORDERING

- 1** TIPO DI LAVABO che si intende installare: semincasso, sottopiano.  
*TYPE OF SINK you want to install: semi-recessed, undercounter.*
- 2** NOME DEL LAVABO ED AZIENDA PRODUTTRICE (se si conosce) oppure inviare direttamente il lavabo o la dima reale in scala 1:1  
*NAME OF SINK AND MANUFACTURER (if known) or send directly the sink or the real template 1:1 scale*
- 3** TIPO DI MARMO a cui corrisponde un gruppo di prezzo, ad esempio: Carrara - Gruppo A  
*TYPE OF MARBLE that correspond a group of price, for example: Carrara - Group A*
- 4** PIANI FUORI SQUADRA è obbligatorio inviare dima reale, scala 1:1  
*NOT RIGHT ANGLED TOPS: real template 1:1 scale is required*

### LAVORAZIONE DEI PIANI

#### TOP'S SHAPES

SPESORE DEL PIANO IN VETRO EXTRACHIARO E EXTRACHIARO SATINATO: 1 cm  
*EXTRA CLEAR COLOURED GLASS TOP AND EXTRA CLEAR SATIN GLASS TOP THICKNESS : 1 cm*

LAVORAZIONE PIANO IN VETRO SPES. 1 cm  
*GLASS TOP PROCESSING THICKNESS 1 cm*



Sagoma / Shape "FILO LUCIDO" (LA9)

SPESORE DEL PIANO IN MARMO, MARMORESINA, QUARZO: 2 cm  
*MARBLE, MARBLE RESIN, QUARTZ TOPS THICKNESS: 2 cm*

LAVORAZIONE PIANO GRUPPI A, B, D SPES. 2 cm  
*GROUPS A, B, D TOP PROCESSING THICKNESS 2 cm*

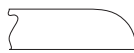

Sagoma / Shape "MEZZO TORO" (LA9)

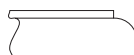

Sagoma / Shape "CLASSICA" (LA6)

**I PREZZI INDICATI NEL PRESENTE LISTINO COMPRENDONO 1 FORO LAVABO**  
**THE PRICES SHOWN IN THIS PRICE LIST INCLUDE A SINK HOLE**

### ALTRE INFORMAZIONI UTILI

#### OTHER USEFUL INFORMATION



ATTENZIONE: a partire da L.166,2 cm i piani per lavabo semincasso soprapiano verranno forniti in due pezzi, tagliati nel centro del foro lavabo

*Please note that from L.166, 2 cm, tops for semi-recessed washbasin will be provided in two pieces, cut in the center of the sink hole*



PIANI CON TAGLIO CAMBIO DI PROFONDITÀ E PIANI CON TAGLIO TERMINALE CURVO non viene applicata nessuna maggiorazione di prezzo

*Top with changing depth and top with curved cut terminal, no overcharge applied*



ALZATINE DI LUNGHEZZA SUPERIORE A 166,2 CM verranno fornite in due pezzi. L'alzata verrà divisa esattamente a metà salvo diversa indicazione specificata nell'ordine

*Backsplashes longer than 166,2 will be provided in 2 pieces. The backsplash is divided in half unless otherwise specified in the order*



**TOP PER BASI PORTALAVABO SEMINCASSO - PROFONDITÀ 34 CM**  
**TOP FOR SEMI-RECESSED WASHBASIN UNIT BASES - DEPTH 34 CM**

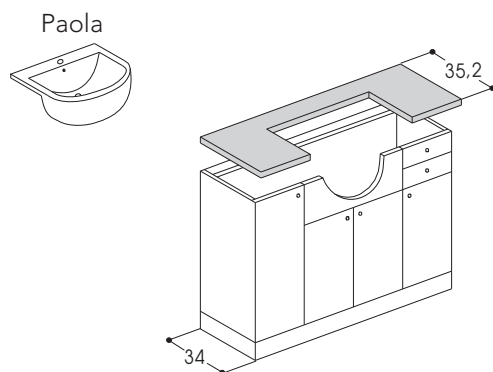

Lunghezza (cm)	Articolo	Vetro extrachiaro colorato	Vetro extrachiaro satinato colorato	Articolo	Articolo	Gruppo A	Gruppo B	Gruppo D
Length (cm)	Code	Extraclear colored glass	Extraclear satin colored glass	Code	Code	A group	B group	D group
		Sp. / Thick. 1 cm				Spessore / Thickness 2 cm		
	Sagoma / Shape "FILO LUCIDO"	Fascia di Prezzo / Price range		Sagoma / Shape "MEZZO TORO"	Sagoma / Shape "CLASSICA"	Fascia di Prezzo / Price range		
		1	2			3	4	6
70	LADT0508	€ 338	€ 575	LA9T0508	LA6T0508	€ 162	€ 243	€ 392
87,5	LADT0510	€ 360	€ 598	LA9T0510	LA6T0510	€ 197	€ 298	€ 484
96,2	LADT0511	€ 375	€ 612	LA9T0511	LA6T0511	€ 214	€ 325	€ 530
105	LADT0512	€ 390	€ 627	LA9T0512	LA6T0512	€ 228	€ 356	€ 547
113,7	LADT0513	€ 406	€ 643	LA9T0513	LA6T0513	€ 245	€ 383	€ 590
122,5	LADT0514	€ 412	€ 650	LA9T0514	LA6T0514	€ 261	€ 412	€ 620
131,2	LADT0515	€ 427	€ 664	LA9T0515	LA6T0515	€ 278	€ 441	€ 663
140	LADT0516	€ 442	€ 679	LA9T0516	LA6T0516	€ 294	€ 468	€ 698
148,7	LADT0517	€ 457	€ 694	LA9T0517	LA6T0517	€ 303	€ 484	€ 728
157,5	LADT0518	€ 464	€ 702	LA9T0518	LA6T0518	€ 312	€ 498	€ 768
166,2	LADT0519	€ 479	€ 716	LA9T0519	LA6T0519	€ 328	€ 524	€ 810
175	LADT0520	€ 495	€ 732	LA9T0520	LA6T0520	€ 336	€ 540	€ 852
183,7	LADT0521	€ 513	€ 750	LA9T0521	LA6T0521	€ 345	€ 556	€ 893
192,5	LADT0522	€ 520	€ 757	LA9T0522	LA6T0522	€ 360	€ 581	€ 935
201,2	LADT0523	€ 536	€ 773	LA9T0523	LA6T0523	€ 376	€ 606	€ 976
210	LADT0524	€ 550	€ 788	LA9T0524	LA6T0524	€ 391	€ 632	€ 1.018

**ALZATINE / BACKSPLASHES**

PREZZO AL METRO LINEARE / PRICE LINEAR METRE

Altezza (cm) Height (cm)	Articolo Code	Vetro extrachiaro colorato	Vetro extrachiaro satinato colorato	Altezza (cm) Height (cm)	Articolo Code	Gruppo A	Gruppo B	Gruppo D
		Extraclear colored glass	Extraclear satin colored glass			A group	B group	D group
		Sp. / Thick. 1 cm				Sp. / Thick. 2 cm		
		Fascia di Prezzo / Price range				Fascia di Prezzo / Price range		
		1	2			3	4	6
7	LADD04.5	€ 86	€ 151	6	LA3D02.4	€ 32	€ 40	€ 104



Aggiunta secondo foro lavabo: € 34 per lavabo semincasso.  
 Additional second hole for washbasin: € 34 for semi-recessed washbasin.

# TOP PER BASI PORTALAVABO INCASSO TOTALE - PROFONDITÀ 34 CM TOP FOR FULLY-RECESSED WASHBASIN UNIT BASES - DEPTH 34 CM

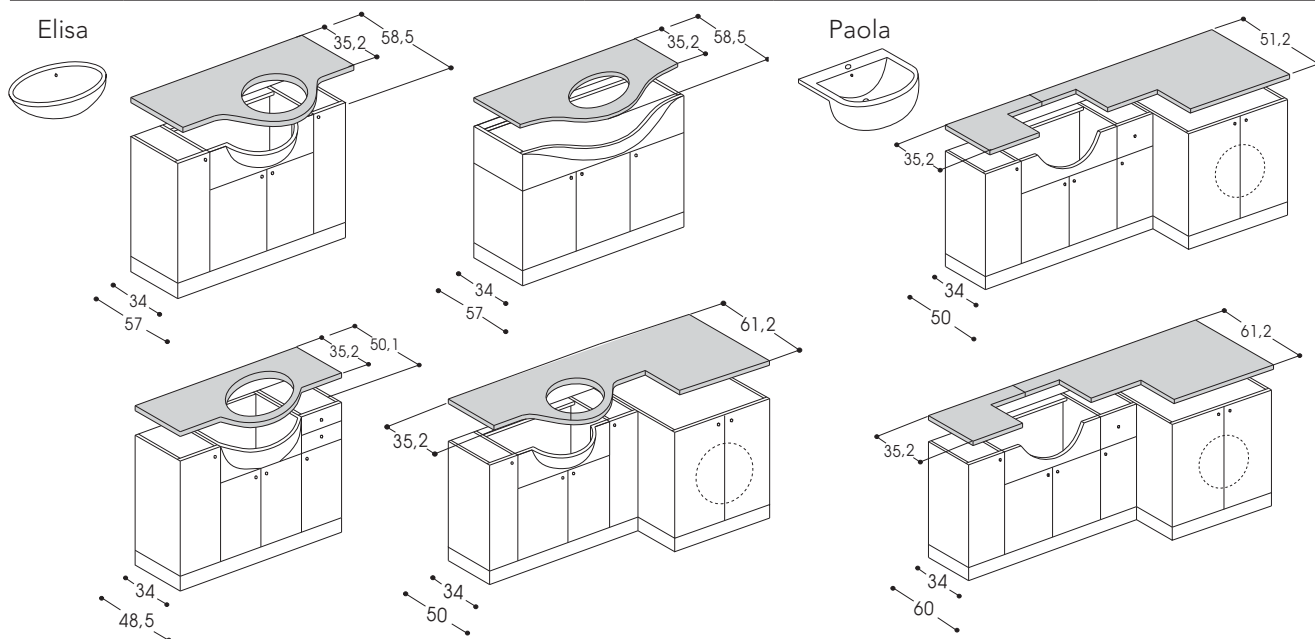

Lunghezza (cm)	Articolo	Vetro extrachiaro colorato	Vetro extrachiaro satinato colorato	Articolo	Articolo	Gruppo A	Gruppo B	Gruppo D
Length (cm)	Code	Extraclear colored glass	Extraclear satin colored glass	Code	Code	A group	B group	D group
	Sagoma / Shape "FILO LUCIDO"	Sp. / Thick. 1 cm		Sagoma / Shape "MEZZO TORO"	Sagoma / Shape "CLASSICA"	Spessore / Thickness 2 cm		
		Fascia di Prezzo / Price range				Fascia di Prezzo / Price range		
		1	2			3	4	6
70	LADT0108	€ 365	€ 602	LA9T0108	LA6T0108	€ 184	€ 322	€ 608
87,5	LADT0110	€ 390	€ 627	LA9T0110	LA6T0110	€ 229	€ 402	€ 760
96,2	LADT0111	€ 412	€ 650	LA9T0111	LA6T0111	€ 252	€ 443	€ 803
105	LADT0112	€ 431	€ 668	LA9T0112	LA6T0112	€ 288	€ 506	€ 846
113,7	LADT0113	€ 450	€ 687	LA9T0113	LA6T0113	€ 313	€ 548	€ 916
122,5	LADT0114	€ 461	€ 698	LA9T0114	LA6T0114	€ 341	€ 598	€ 959
131,2	LADT0115	€ 479	€ 716	LA9T0115	LA6T0115	€ 365	€ 641	€ 1.027
140	LADT0116	€ 498	€ 736	LA9T0116	LA6T0116	€ 394	€ 689	€ 1.078
148,7	LADT0117	€ 520	€ 757	LA9T0117	LA6T0117	€ 409	€ 715	€ 1.119
157,5	LADT0118	€ 528	€ 765	LA9T0118	LA6T0118	€ 423	€ 741	€ 1.184
166,2	LADT0119	€ 550	€ 788	LA9T0119	LA6T0119	€ 446	€ 782	€ 1.250
175	LADT0120	€ 568	€ 806	LA9T0120	LA6T0120	€ 453	€ 794	€ 1.310
183,7	LADT0121	€ 588	€ 825	LA9T0121	LA6T0121	€ 476	€ 834	€ 1.375
192,5	LADT0122	€ 598	€ 835	LA9T0122	LA6T0122	€ 498	€ 873	€ 1.441
201,2	LADT0123	€ 617	€ 854	LA9T0123	LA6T0123	€ 521	€ 913	€ 1.506
210	LADT0124	€ 635	€ 872	LA9T0124	LA6T0124	€ 544	€ 954	€ 1.572

## ALZATINE / BACKSPLASHES

PREZZO AL METRO LINEARE / PRICE LINEAR METRE



Altezza (cm) Height (cm)	Articolo Code	Vetro extrachiaro colorato	Vetro extrachiaro satinato colorato	Altezza (cm) Height (cm)	Articolo Code	Gruppo A	Gruppo B	Gruppo D
		Extraclear colored glass	Extraclear satin colored glass			A group	B group	D group
		Sp. / Thick. 1 cm				Sp. / Thick. 2 cm		
		Fascia di Prezzo / Price range				Fascia di Prezzo / Price range		
		1	2			3	4	6
7	LADD04.5	€ 86	€ 151	6	LA3D02.4	€ 32	€ 40	€ 104

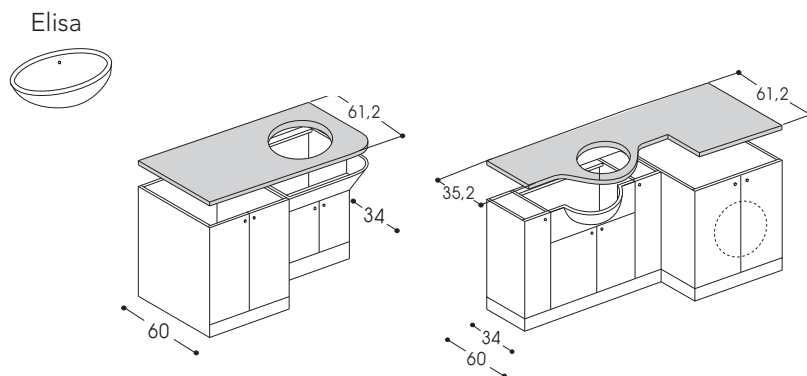

Aggiunta secondo foro lavabo: € 34 per lavabo semincasso, € 95 per lavabo incasso totale.  
Additional second hole for washbasin: € 34 for semi-recessed washbasin, € 95 for fully-recessed washbasin.

TOP PER BASI PORTALAVABO INCASSO TOTALE PROF. 34 CM E BASE PORTALAVATRICE PROF. 60 CM  
TOP FOR FULLY-RECESSED WASHBASIN UNIT BASES - DEPTH 34 CM



Lunghezza (cm)	Articolo	Vetro extrachiaro colorato	Vetro extrachiaro satinato colorato	Articolo	Articolo	Gruppo A	Gruppo B	Gruppo D
Length (cm)	Code	Extraclear colored glass	Extraclear satin colored glass	Code	Code	A group	B group	D group
		Sp. / Thick. 1 cm				Spessore / Thickness 2 cm		
	Sagoma / Shape "FILO LUCIDO"	Fascia di Prezzo / Price range		Sagoma / Shape "MEZZO TORO"	Sagoma / Shape "CLASSICA"	Fascia di Prezzo / Price range		
		1	2			3	4	6
140	LADT0616	€ 498	€ 736	LA9T0616	LA6T0616	€ 436	€ 763	€ 1.167
148,7	LADT0617	€ 520	€ 757	LA9T0617	LA6T0617	€ 453	€ 793	€ 1.219
166,2	LADT0619	€ 550	€ 788	LA9T0619	LA6T0619	€ 494	€ 864	€ 1.322
175	LADT0620	€ 568	€ 806	LA9T0620	LA6T0620	€ 511	€ 879	€ 1.371
183,7	LADT0621	€ 588	€ 825	LA9T0621	LA6T0621	€ 527	€ 922	€ 1.418
192,5	LADT0622	€ 598	€ 835	LA9T0622	LA6T0622	€ 551	€ 966	€ 1.486
201,2	LADT0623	€ 617	€ 854	LA9T0623	LA6T0623	€ 576	€ 1.010	€ 1.554
210	LADT0624	€ 635	€ 872	LA9T0624	LA6T0624	€ 601	€ 1.054	€ 1.622

ALZATINE / BACKSPLASHES

PREZZO AL METRO LINEARE / PRICE LINEAR METRE

Altezza (cm) Height (cm)	Articolo Code	Vetro extrachiaro colorato Extraclear colored glass	Vetro extrachiaro satinato colorato Extraclear satin colored glass	Altezza (cm) Height (cm)	Articolo Code	Gruppo A A group	Gruppo B B group	Gruppo D D group
		Sp. / Thick. 1 cm				Sp. / Thick. 2 cm		
		Fascia di Prezzo / Price range				Fascia di Prezzo / Price range		
		1	2			3	4	6
7	LADD04.5	€ 86	€ 151	6	LA3D02.4	€ 32	€ 40	€ 104



Aggiunta secondo foro lavabo: € 95 per lavabo incasso totale.  
Additional second hole for washbasin: € 95 for fully-recessed washbasin.

**TOP LINEARI PER BASI - PROFONDITÀ 34 CM**  
**LINEAR TOP FOR BASES - DEPTH 34 CM**

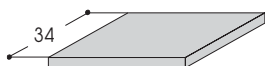

Lunghezza (cm)	Articolo	Vetro extrachiaro colorato	Vetro extrachiaro satinato colorato	Articolo	Articolo	Gruppo A	Gruppo B	Gruppo D
Length (cm)	Code	Extraclear colored glass	Extraclear satin colored glass	Code	Code	A group	B group	D group
	 Sagoma / Shape "FILO LUCIDO"	Sp. / Thick. 1 cm		 Sagoma / Shape "MEZZO TORO"	 Sagoma / Shape "CLASSICA"	Spessore / Thickness 2 cm		
		Fascia di Prezzo Price range				Fascia di Prezzo Price range		
		1	2			3	4	6
17,5	LADT0C02	€ 107	€ 345	LA9T0C02	LA6T0C02	€ 63	€ 90	€ 140
26,2	LADT0C03	€ 119	€ 356	LA9T0C03	LA6T0C03	€ 73	€ 105	€ 159
35	LADT0C04	€ 130	€ 367	LA9T0C04	LA6T0C04	€ 82	€ 120	€ 179
52,5	LADT0C06	€ 153	€ 390	LA9T0C06	LA6T0C06	€ 124	€ 179	€ 268
70	LADT0C08	€ 179	€ 416	LA9T0C08	LA6T0C08	€ 139	€ 220	€ 370
87,5	LADT0C10	€ 197	€ 434	LA9T0C10	LA6T0C10	€ 174	€ 276	€ 461
96,2	LADT0C11	€ 208	€ 445	LA9T0C11	LA6T0C11	€ 191	€ 303	€ 507
105	LADT0C12	€ 223	€ 460	LA9T0C12	LA6T0C12	€ 206	€ 333	€ 524

**TOP LINEARE PER BASE PORTALAVATRICE - PROFONDITÀ 50 CM**  
**LINEAR TOP FOR WASHING-MACHINE UNIT BASE - DEPTH 50 CM**

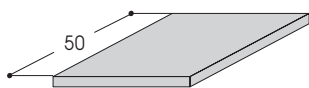

Lunghezza (cm)	Articolo	Vetro extrachiaro colorato	Vetro extrachiaro satinato colorato	Articolo	Articolo	Gruppo A	Gruppo B	Gruppo D
Length (cm)	Code	Extraclear colored glass	Extraclear satin colored glass	Code	Code	A group	B group	D group
	 Sagoma / Shape "FILO LUCIDO"	Sp. / Thick. 1 cm		 Sagoma / Shape "MEZZO TORO"	 Sagoma / Shape "CLASSICA"	Spessore / Thickness 2 cm		
		Fascia di Prezzo Price range				Fascia di Prezzo Price range		
		1	2			3	4	6
70	LADT0A08	€ 223	€ 460	LA9T0A08	LA6T0A08	€ 160	€ 298	€ 492

**TOP LINEARE PER BASE PORTALAVATRICE - PROFONDITÀ 60 CM**  
**LINEAR TOP FOR WASHING-MACHINE UNIT BASE - DEPTH 60 CM**

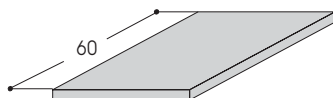

Lunghezza (cm)	Articolo	Vetro extrachiaro colorato	Vetro extrachiaro satinato colorato	Articolo	Articolo	Gruppo A	Gruppo B	Gruppo D
Length (cm)	Code	Extraclear colored glass	Extraclear satin colored glass	Code	Code	A group	B group	D group
	 Sagoma / Shape "FILO LUCIDO"	Sp. / Thick. 1 cm		 Sagoma / Shape "MEZZO TORO"	 Sagoma / Shape "CLASSICA"	Spessore / Thickness 2 cm		
		Fascia di Prezzo Price range				Fascia di Prezzo Price range		
		1	2			3	4	6
70	LADT0D08	€ 223	€ 460	LA9T0D08	LA6T0D08	€ 180	€ 332	€ 521

TOP  
TOP

PIANI CON VASCA INTEGRATA PER BASI PORTALAVABO INCASSO TOTALE - PROF. 34/57 CM  
 FULLY RECESSED INTEGRATED WASHBASIN SURFACES FOR RECESSED WASHBASIN UNITS - DEPTH 34/57 CM

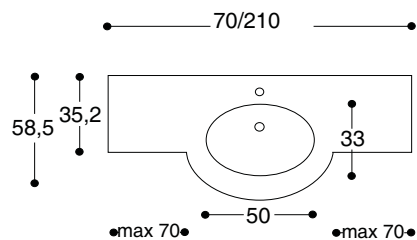

Profondità vasca 13 cm / Basin D. 13 cm  
 Senza troppo pieno / Without over-flow

Lunghezza (cm)	Articolo	Vetro extrachiaro colorato	Vetro extrachiaro satinato colorato	Articolo	Tecnoril
Length (cm)	Code	Extraclear colored glass	Extraclear satin colored glass	Code	Tecnoril
	Sagoma / Shape "FILO LUCIDO"	Sp. / Thick. 1 cm		Sagoma / Shape "FILO LUCIDO"	Sp. / Thick. 1,2 cm
		Fascia di Prezzo / Price range			Fascia di Prezzo / Price range
		1	2		7
70	LADT7908	€ 838	€ 1.025	LA0T6908	€ 678
87,5	LADT7910	€ 893	€ 1.076	LA0T6910	€ 768
96,2	LADT7911	€ 929	€ 1.111	LA0T6911	€ 814
105	LADT7912	€ 966	€ 1.146	LA0T6912	€ 836
113,7	LADT7913	€ 1.003	€ 1.182	LA0T6913	€ 881
122,5	LADT7914	€ 1.024	€ 1.201	LA0T6914	€ 927
131,2	LADT7915	€ 1.058	€ 1.233	LA0T6915	€ 972
140	LADT7916	€ 1.090	€ 1.264	LA0T6916	€ 994
148,7	LADT7917	€ 1.131	€ 1.304	LA0T6917	€ 1.040
157,5	LADT7918	€ 1.148	€ 1.320	LA0T6918	€ 1.085
166,2	LADT7919	€ 1.190	€ 1.358	LA0T6919	€ 1.130
175	LADT7920	€ 1.223	€ 1.390	LA0T6920	€ 1.153
183,7	LADT7921	€ 1.255	€ 1.422	LA0T6921	€ 1.198
192,5	LADT7922	€ 1.276	€ 1.442	LA0T6922	€ 1.243
201,2	LADT7923	€ 1.313	€ 1.477	LA0T6923	€ 1.288
210	LADT7924	€ 1.347	€ 1.509	LA0T6924	€ 1.311

ALZATINE / BACKSPLASHES

PREZZO AL METRO LINEARE / PRICE LINEAR METRE

Altezza (cm)	Articolo	Vetro extrachiaro colorato	Vetro extrachiaro satinato colorato	Altezza (cm)	Articolo	Tecnoril
Height (cm)	Code	Extraclear colored glass	Extraclear satin colored glass	Height (cm)	Code	Tecnoril
		Sp. / Thick. 1 cm				Sp. / Th. 1,2 cm
		Fascia di Prezzo / Price range				Fascia di Prezzo / Price range
		1	2			7
7	LADD04.5	€ 86	€ 151	6,8	LA0D05.A	€ 95